

A-Z MONTANA guide

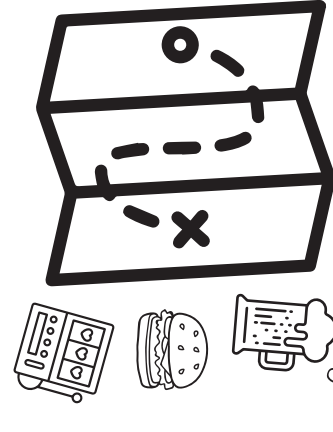

Barfly

The last long weekend of summer is almost here, and I hope you're hitting the road! With a whole extra day to explore, why not cross the border and spend a few days in Montana? Montana is awesome. There are SO many places to see & adventures to have in Montana, so this guide is an alphabetical list of some of my favourite places, landmarks & random things I've found when I've been out exploring!

So go! Drive safe! Be nice! Have fun! Bring back a case of coconut La Croix for me!

D Into ghosts and spooky stuff? I'm not. But the **DUDE RANCHER LODGE** in Billings has a ghost that I had to deal with in real life. Other than that it was a really great night. Super cute decor!

C Right after the Sweetgrass border crossing is a little town named Sunburst. Not much going on in Sunburst other than the **CHURCH BAR**. A bar in an old church. It's actually called The Mint Bar, but I like to call it the Church Bar. There's even a bunkhouse so you can sleep over! Thursday is **CLAM NIGHT**, which is also a C-word.

B **BISON** Located about 1 hour North of Missoula, the National Bison Range is one of the oldest National Wildlife Refuges in the US. Along with the bison herd, you're likely to see antelope and a shiloh of different birds.

B **BISCUITS AND GRavy**. Guaranteed to be on every menu in every restaurant or diner that you stop in. Totally hits the spot after a night of \$2 beer!

I couldn't decide which B was more important, so here are two.

A **ALZADA** is a small town with a population of about 29. This town used to be named Stoneville, after a local bartender, Lou Stone. Not sure if old Lou is still kickin' but the Stoneville Saloon sure is, and it's definitely worth a visit if you're into drinking \$2 beers in the coolest bar in the world. If you're not, you may as well stop reading now...

Z Cajun food in Montana seems weird, but Cafe **ZYDECO** is so good! Gumbo, jambalaya, shrimp & grits, po' boys! You can find Cafe Zydeco in Missoula, Billings, Bozeman & Helena!

Y **YELLOWSTONE**, but not the park, the river. Yellowstone River is the last free-flowing river in the lower 48 states. As it flows through MT, it sees many different landscapes, from deep-walled canyons to wide & lazy farm land.

X Do you know what **XENAGOGY** means? It means like a guidebook sort of thing. This is sort of like a Montana guidebook kind of? So there you go. X is for Xenagogy.

W Remember I mentioned all those Mint Bars? One of them is in **WHITEHALL**. It burnt down a few years ago, but it has been rebuilt. There is a bartender there named Bobbi who has a photo album on her phone of all the patrons who have passed out at her bar.

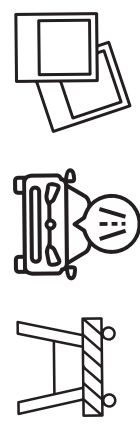

E **EVEL KNEVEL** was born in Butte so they have a big crazy street party in his honor every year. It already happened this year, but maybe plan ahead for next year! (evelknevel4days.org)

F Also in Butte is the **FREEWAY TAVERN**. Famous for their Pork Chop Sandwich, and the fish burger is pretty good too! Evel Kneivel used to hang out there, and I won \$40 on the slot machines.

G Speaking of slot machines, one of my favorite things to do in Montana is **GAMBLE!** Belly up to almost any bar and look for a jar that says "Shake-A-Day". It will usually cost \$1, and you get one chance to roll 5 dice. If you roll all the same number, you win the whole pot!

H I love a good **HAMBURGER**, and the ones at the Missoula Club (in Missoula, obv) are next level. Nothing else on the menu, just burgers & beer. So don't go if you don't like burgers & beer.

H Another good Montana "H" is **HUCKLEBERRY!** Huckleberries are friggin' everywhere here, and mid-July to late August is prime pickin' season. Pick up some locally made jam or pie, or just pull over and pick some yourself!

I Ummm...the **I-90** is a pretty good highway...



J If you find yourself in the great little town of Anaconda, make sure to stop in to **JFK BAR!** Shuffleboard, **JUKE BOX**, cheap beer & friendly locals make JFK Bar a fun place to spend a couple hours!

K Michael **KEATON** lives just outside of Livingston which is pretty neat. I s u p e r d o o d.

L I don't know too much about those **LEWIS AND CLARK** guys other than they were explorers and they had to walk everywhere, but everything in Montana is named after them. Don't eat at "Clark & Lewies" in Great Falls. It's real bad.

M If someone tells you to meet them at the **MINT BAR**, make sure to ask them which one, as there are at least 15 different Mint Bar's in Montana, and they're all awesome. So why is the Mint Bar such a popular bar name? Back in the mining boom days, the Mint is where all the miners & railroad workers would hang out!

N Mint Bars: Livingston, Lewiston, Big Sandy, Whitehall, Chinook, Townsend, Libby, Belgrade, Malta, Opheim, White Sulphur Springs, Shelby, Froid, Marinistate

Did you know there are 9 **NATIONAL PARKS** in Montana? There are: Big Horn Canyon, Big Hole National Battlefield, Glacier National Park, Fort Union Trading Post, Lewis & Clark Historical Trail, Grant-Kohrs Ranch, Nez Perce Historical Park, Glacier National Park, and Yellowstone!

O The state motto is "**ORO Y PLATA**" which is Spanish for gold & silver - two of the minerals that gave Montana it's nickname. (See "T")

Ok, there are a lot of great P things to discuss.

P First and most important **P** on my list goes to **PIANO PAT!** Pat plays the organ at the Sip N Dip in Great Falls, and is the real star of that Mermaid Show, in my opinion. She's old and awesome, and while we're on the topic of the Sip n Dip, if you book in advance you can pay \$100 and swim with the mermaids! Gross.

P In my long life of being alive, the best bar name that I have ever come across is called **PISSERS PALACE** in Butte. It is every bit as good as you'd think it would be with that name.

P There is a town called **PRAY** that you can buy for real cheap. The whole town! And Jeff Bridges lives there! (I'm not sure why Jeff Bridges doesn't just buy the town, you know?)

P This **P** is my fave - **THE PEKIN NOODLE PARLOR** is America's Oldest Chinese Restaurant! Founded in Butte in 1911, this place still contains all of it's original furnishings, including chairs, tables & dishes. Located in Butte's old Red Light District there are some pretty good stories about the noodle parlor doubling as a brothel!

Q I just gave you four P's, so I'm going to skip over "Q".

R Picture it - Missoula, summer of 1884. Theodore **ROOSEVELT** arrives at Nolan's Hotel after many days of riding through Eastern Montana. It was late and he needed a room. One of the bar patrons was drunk and shooting off his guns, and he called Roosevelt "Four Eyes" regarding his glasses (lol). Roosevelt, being a very skilled boxer, ended up knocking the guy out, taking away his guns, and locking him in a shed!

S Sort of like how there are so many Mint Bars, there are also a whole bunch of bars named **STOCKMANS BAR**. At least 12, according to Google. The Stockman Bars are named after all the cattlemen that would hang out there!

T Montana is known as the **TREASURE STATE** because of it's rich mineral reserves. The mountains of Montana have yielded fortunes of silver & gold since the mid 1800's!

U I've never driven through Montana without the highways being **UNDER CONSTRUCTION**. So stay fueled up and make sure you have lots of snacks!

V There is a great bar called the Silverspur Saloon and it's located in **VAUGHN**. Not much else is located in Vaughn, though.



YOU GOTTA KNOW ~~WHEN~~ HOW TO FOLD EM

download & print the PDF on a regular piece of 8.5" x 11" paper, and follow these easy steps to fold into a tiny six-page book!

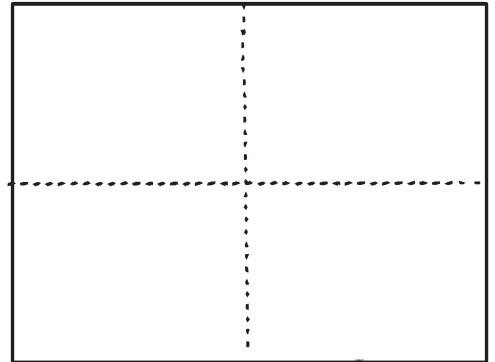
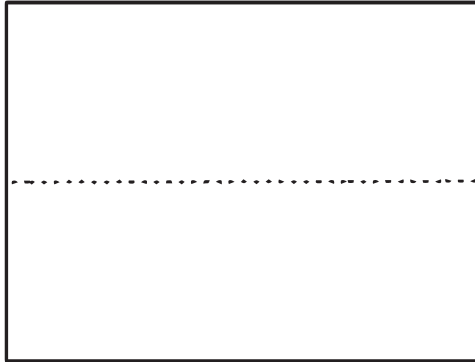
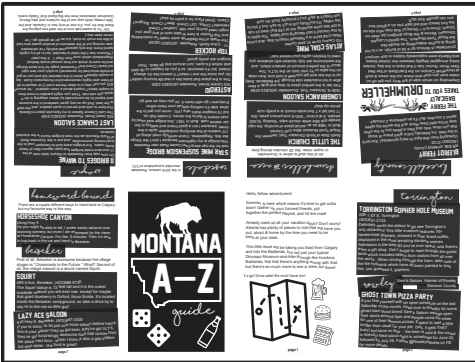

1 this is what your piece of paper should look like.

2 fold it in half.

3 fold it in half the other way.

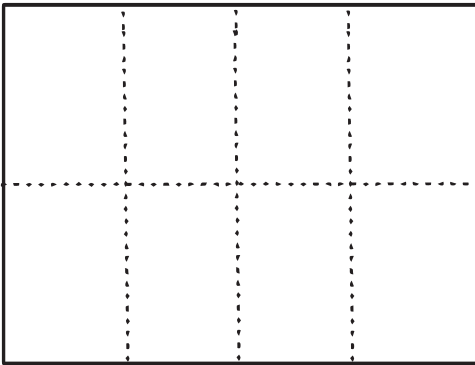

4 fold it in half two more times so you have 8 sections.

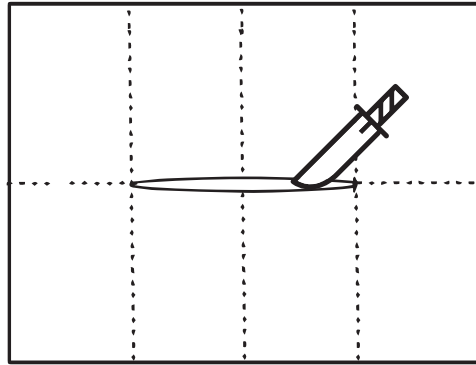

5 get a blade and slice the page in the middle. look at the picture so you don't screw it up!

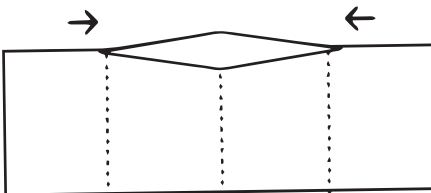

6 fold it in half and push edges towards the middle so the sliced part opens up like a diamond.

7 keep pushing the edges together until the diamond does a weird thing and looks like this

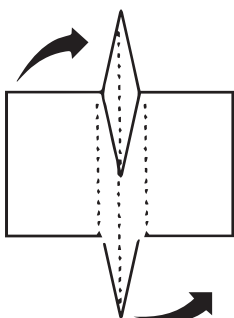
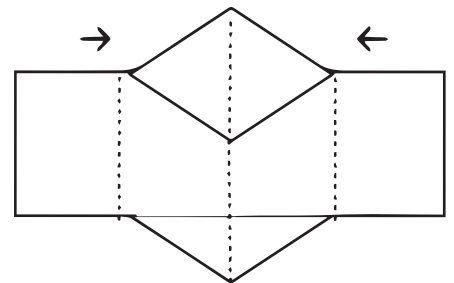

8 now you gotta try to sort of flatten it out and push it down like a little booklet. pay attention to the page numbers, that will help for real.

9 now it should look like a book! go over the creases to make them sharp. I use a boning tool (best name) but you can use anything that's kinda hard/soft.

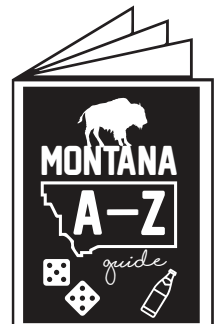

ok! that's it! you're done! now put it in your wallet or your bag and have it ready for the next time you're itchin' to get outta town!